

OWNER'S GUIDE &

INSTALLATION INSTRUCTIONS

Thru-hull Depth Transducer

Low Profile, Flush, and Retractable Models

IMPORTANT: Please read the instructions completely before proceeding with the installation. These instructions supersede any other instructions in your instrument manual if they differ.

CAUTION: NEVER USE SOLVENTS!

Cleaners, fuel, paint, sealants, and other products may contain strong solvents, such as acetone, which attack many plastics greatly reducing their strength.

Applications

- **Plastic** housing recommended for fiberglass or metal hulls only. *Never* install a plastic transducer in a wood hull, since swelling of the wood can possibly fracture the plastic.
- **Bronze** housing recommended for fiberglass or wood hulls. *Never* install a bronze housing in an aluminum hull, because electrolytic corrosion will occur.
- **Stainless steel** housing compatible with all hull materials.
Recommended for aluminum hulls to prevent electrolytic corrosion *provided the stainless steel housing is isolated from the metal hull.*
- *Never* install a metal housing in a vessel with a positive ground system.

Identify Your Model

To identify your model, see the cable tag.

Tools & Materials

- Safety goggles
- Dust mask
- Electric drill with 10mm (3/8") or larger chuck capacity
- Drill bit: 3mm or 1/8"
- Hole saw (see table on page 1)
- Countersink tool (installing a flush housing)
- Sandpaper
- Mild household detergent or weak solvent (such as alcohol)
- File (installation in a metal hull)
- Marine sealant (suitable for below waterline)
- Slip-joint pliers (installing a metal housing)
- Zip-ties
- Water-based antifouling paint (**MANDATORY IN SALT WATER**)
- Installation in a cored fiberglass hull (see page 4):
 - Hole saw for hull interior: (see table on this page)
 - Fiberglass cloth and resin
 - or Cylinder, wax, tape, and casting epoxy

Record the information found on the cable tag for future reference.

Part No. 31-241-2-01 Date 09/06 Frequency 200 kHz - CG-

AIRBORNE # 117 # HA121317

0/1 1018501

Retractable
Low Profile
P17

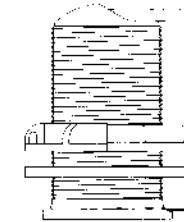
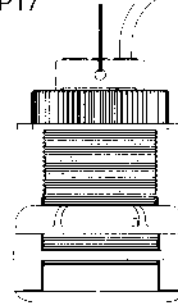

Flush
P219/B119

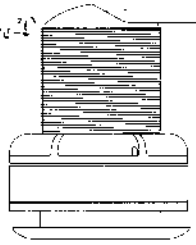

Low Profile
P319

Mounting Location

- The water flowing across the hull *must* be smooth with a minimum of bubbles and turbulence (especially at high speeds).
Caution: DO NOT MOUNT near water intake or discharge openings, or behind strakes, fittings, or hull irregularities.
- The transducer *must* be continuously immersed in water.
- The transducer beam *must* be unobstructed by the keel or propeller shaft(s).
- Choose a location away from interference caused by power and radiation sources such as: the propeller(s) and shaft(s), other machinery, other echosounders, and other cables. The lower the noise level, the higher the echosounder gain setting that can be used.
- Choose a location with a deadrise angle of 20° or less, so the transducer beam will be aimed at the bottom.
- Choose an accessible spot inside the vessel with adequate headroom for the height of the housing, tightening the nuts, and removing any insert. (see the table below).

Model	Minimum Headroom	Outside Hull Hole Saw Size	Cored Fiberglass Hull Only Hull Interior Hole Saw Size
B22, B117, P19, P319	95 mm (3-3/4")	51 mm or 2"	60 mm or 2-3/8"
B124	161 mm (6-3/8")	51 mm or 2"	60 mm or 2-3/8"
SS555	90 mm (3-1/2")	57 mm or 2-1/4"	NA
SS575	95 mm (3-3/4")	57 mm or 2-1/4"	NA
Flush: B21, B119, P219, P269	100 mm (4")	51 mm or 2"	60 mm or 2-3/8"
Retractable: B17, B21, B119, P17, P217, P314, SS577	200 mm (8")	51 mm or 2"	60 mm or 2-3/8"

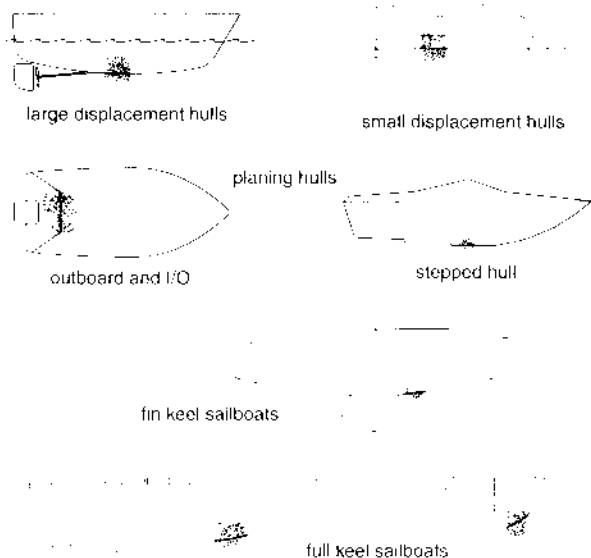

Figure 1. Best location for transducer
Copyright © 2005 Ammar Technology Corp.

Hull Types (see Figure 1)

- **Displacement hull powerboats**—Locate amidships near the centerline. The starboard side of the hull where the propeller blades are moving downward is preferred.
- **Planing hull powerboats**—Mount well aft, on or near the centerline, and well inboard of the first set of lifting strakes to insure that the transducer will be in contact with the water at high speeds. The starboard side of the hull where the propeller blades are moving downward is preferred.
Outboard and I/O—Mount just forward of the engine(s).
Inboard—Mount well ahead of the propeller(s) and shaft(s).
Stepped hull—Mount just ahead of the first step.
- **Boat capable of speeds above 25kn (29MPH)**—Review the installation location and operating results of similar boats before proceeding.
- **Fin keel sailboats**—Mount on or as close as possible to the centerline and forward of the fin keel 300–600mm (1–2').
- **Full keel sailboats**—Locate amidships and away from the keel at the point of minimum deadrise.

Fairing

Caution: Never use a fairing with a plastic housing; the protruding transducer would be vulnerable to damage from impact.

Generally, the transducer is mounted *without* a fairing. However, nearly all vessels have some deadrise angle at the transducer mounting location. If the transducer is mounted directly to the hull, the sound beam will not be aimed straight down. It will be tilted at the same angle as the deadrise angle. A fairing is recommended if the deadrise angle at the mounting location exceeds 10°, and you are installing a **METAL** housing only.

Installation

Cored fiberglass hull—Follow separate instructions on page 4.

Hole Drilling

Warning: Always wear safety goggles and a dust mask.

1. Drill a 3 mm or 1/8" pilot hole from inside the hull. If there is a rib, strut, or other hull irregularity near the selected mounting location, drill from the outside.

2. Using the appropriate size **OUTSIDE HULL** hole saw, cut a hole from outside of the hull perpendicular to the hull surface (see table on page 1).

Flush housing—Use a countersink tool to make a "seat" in the hull.

3. Sand and clean the area around the hole, inside and outside, to ensure that the marine sealant will adhere properly to the hull. If there is any petroleum residue inside the hull, remove it with either mild household detergent or a weak solvent (alcohol) before sanding.

Metal hull—Remove all burrs with a file and sandpaper.

Bedding

Caution: Never pull, carry, or hold the transducer by its cable; this may sever internal connections.

Apply a 2mm (1/16") thick layer of marine sealant around the lip of the housing that contacts the hull and up the sidewall of the housing. The sealant *must* extend 6mm (1/4") higher than the combined thickness of the hull, washer, any spacer, and the hull nut (see Figure 2). This will ensure there is sealant in the threads to seal the hull and to hold the hull nut securely in place.

Stainless steel housing in a metal hull—To prevent electrolytic corrosion, the stainless steel housing *must* be isolated from the metal hull. Slide the isolation bushing onto the housing (see Figure 3). Apply additional marine sealant to the surfaces of the bushing that will contact the hull.

Installing

Note: Ignore any arrows on the housing, insert, and blanking plug.

1. From outside the hull, push the housing into the mounting hole using a twisting motion to squeeze out excess marine sealant.
2. From inside the hull, slide the washer onto the housing (see Figure 2).
B117, P319, SS575—Also slide the spacer onto the housing and rest it against the washer.
Note: *DO NOT* use the spacer if there is insufficient space to tighten the nut or it is within 11 mm (1/2") of the top of the housing.
3. Screw the hull nut in place *being sure* the notch on the upper rim of the housing is still positioned forward toward the bow.
Wood hull—Allow for the wood to swell.
Plastic housing—If your housing has wrenching flats, *do not* clamp tightly possibly causing the housing to fracture.
Plastic hull nut—**HAND-TIGHTEN** only. *Do not* over tighten.
Metal hull nut—Tighten with slip-joint pliers.
Metal hull—Use the spacer if there are not enough threads to tighten the hull nut.
Cored Fiberglass Hull—*Do not* over tighten, crushing the hull.
4. Remove any excess marine sealant on the outside of the hull to ensure smooth water flow over the transducer.

5. Retractable models only

Warning: The O-rings must be intact and well lubricated to make a watertight seal.

- After the marine sealant cures, inspect the O-rings on the insert (replace if necessary) and lubricate them with the silicone lubricant supplied. Slide the insert into the housing. Seat the insert into place with a twisting motion until the key fits into the notch. *Be careful* not to rotate the housing and disturb the marine sealant. Screw the cap nut in place and **HAND-TIGHTEN** only. *Do not* over tighten.

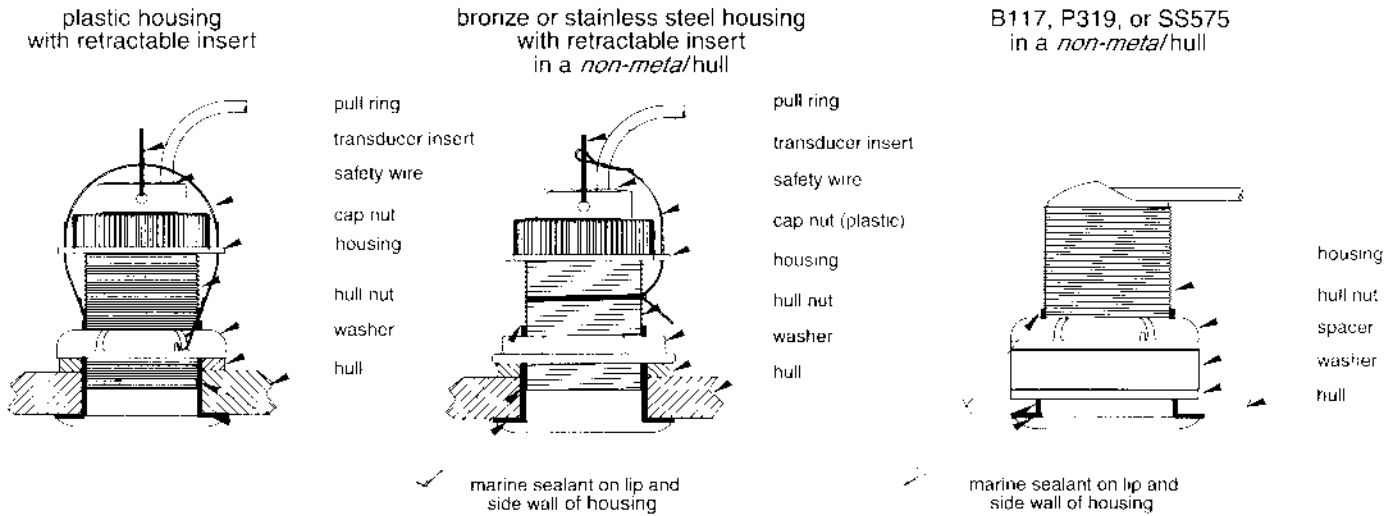

Figure 2. Bedding and installing (low profile housings shown)

Copyright © 2006 Airmar Technology Corp

Warning: Always attach the safety wire to prevent the insert from backing out in the unlikely event that the cap nut fails or is screwed on incorrectly.

- Attach the safety wire.

Plastic housing—Attach the safety wire to one eye in the hull nut. Lead the wire in a counterclockwise direction and thread it through one eye in the cap nut, the pull ring, the second eye in the cap nut, and the second eye in the hull nut. Twist the wire securely to itself.

Metal housing—Wrap one end of the safety wire tightly around the housing and twist it together with the long end. Lead the wire straight up and through the eye in the cap nut. Loop the wire through the pull ring and twist it securely to itself.

Cable Routing & Connecting

Caution: If your transducer came with a connector, do not remove it to ease cable routing. If the cable must be cut and spliced, use Airmar's splash-proof Junction Box No. 33-035 and follow the instructions provided. Cutting the cable or removing the waterproof connector, except when using Airmar's junction box, will void the transducer warranty.

1. Route the cable to the instrument, *being careful* not to tear the cable jacket when passing it through the bulkhead(s) and other parts of the boat. To reduce electrical interference, separate the transducer cable from other electrical wiring and the engine. Coil any excess cable and secure it in place using zip-ties to prevent damage.
2. Refer to the echosounder owner's manual to connect the transducer to the instrument.

Checking for Leaks

Warning: DO NOT leave the boat in the water unchecked for several days.

When the boat is placed in the water, **immediately** check the thru-hull transducer for leaks. Note that very small leaks may not be readily observed. It is best not to leave the boat in the water for more than 3 hours before checking it again. If there is a small leak, there may be considerable bilge water accumulation after 24 hours. If a leak is observed, repeat "Bedding" and "Installing" **immediately** (see page 2).

Retractable Models Only—Blanking Plug

Warning: The O-rings must be intact and well lubricated to make a watertight seal.

1. On the blanking plug, inspect the O-rings (replace if necessary) and lubricate them with the silicone lubricant supplied or petroleum jelly (Vaseline®).
2. Remove the paddlewheel insert from the housing by removing the safety wire and unscrewing the cap nut (see Figure 2).
3. With the blanking plug ready in one hand, pull the paddlewheel insert most of the way out. Remove the insert and rapidly replace it with the blanking plug. Seat it into place with a pushing twisting motion until the key fits into the notch in the housing. With practice, only 250ml (10oz.) of water will enter the boat. Screw the cap nut in place and **HAND-TIGHTEN** only. *Do not* over tighten.

Warning: Always attach the safety wire to prevent the insert from backing out in the unlikely event that the cap nut fails or is screwed on incorrectly.

4. Reattach the safety wire.

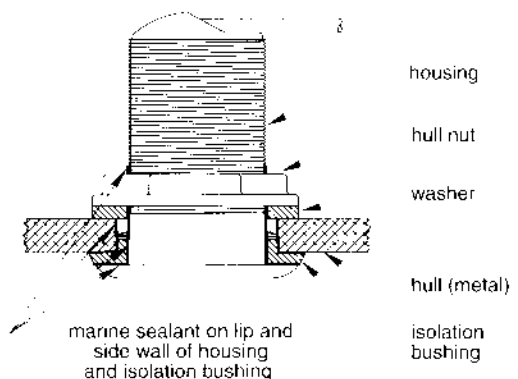

Figure 3. Stainless steel housing in a metal hull (SS555 shown)

Copyright © 2006 Airmar Technology Corp

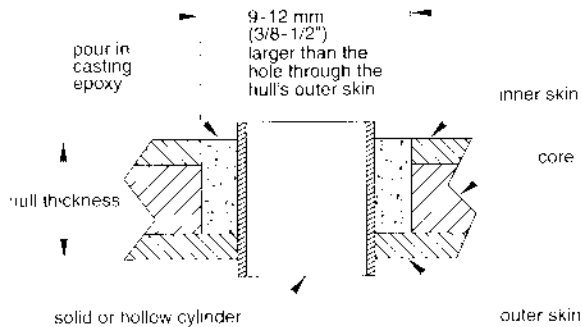

Figure 4. Preparing a cored fiberglass hull

Copyright © 2006 Airmar Technology Corp.

Installation in a Cored Fiberglass Hull

The core (wood or foam) *must* be cut and sealed carefully. The core *must* be protected from water seepage, and the hull *must* be reinforced to prevent it from crushing under the hull nut allowing the housing to become loose.

Warning: Always wear safety goggles and a dust mask.

1. Drill a 3 mm or 1/8" pilot hole from inside the hull. If there is a rib, strut, or other hull irregularity near the selected mounting location, drill from the outside. (If the hole is drilled in the wrong location, drill a second hole in a better location. Apply masking tape to the outside of the hull over the incorrect hole and fill it with epoxy.)
2. Using the appropriate size OUTSIDE HULL hole saw, cut a hole from outside the hull through the *outer* skin only (see table on page 1) (see Figure 4).
3. From inside the hull using the appropriate size HULL INTERIOR hole saw, cut through the *inner* skin and most of the core (see table on page 1). The core material can be very soft. Apply only light pressure to the hole saw after cutting through the *inner* skin to avoid accidentally cutting the *outer* skin.
4. Remove the plug of core material, so the *inside* of the outer skin and the inner core of the hull is fully exposed. Sand and clean the inner skin, core, and the outer skin around the hole.

Caution: Completely seal the hull to prevent water seepage into the core.

5. If you are skilled with fiberglass, saturate a layer of fiberglass cloth with a suitable resin and lay it inside the hole to seal and strengthen the core. Add layers until the hole is the correct diameter.
Alternatively, a hollow or solid cylinder of the correct diameter can be coated with wax and taped in place. Fill the gap between the cylinder and hull with casting epoxy. After the epoxy has set, remove the cylinder.
6. Sand and clean the area around the hole, inside and outside, to ensure that the marine sealant will adhere properly to the hull. If there is any petroleum residue inside the hull, remove it with either mild household detergent or a weak solvent (alcohol) before sanding.
7. Proceed with "Bedding", "Installing", and "Cable Routing & Connecting" (see pages 2 and 3).

Maintenance, Parts & Replacement

Antifouling Paint

Surfaces exposed to salt water *must* be coated with antifouling paint. Use *WATER-BASED* antifouling paint only. *Never* use ketone based antifouling paint, since ketones can attack many plastics possibly damaging the transducer. Apply antifouling paint every 6 months or at the beginning of each boating season.

Cleaning

Aquatic growth can accumulate rapidly on the transducer's surface, reducing its performance within weeks. Clean the surface with a Scotch-Brite® scour pad and mild household detergent, *being careful* to avoid making scratches. If the fouling is severe, lightly wet sand it with fine grade wet/dry paper.

Replacement Parts

Lost, broken, or worn parts should be replaced immediately. Any O-rings must be free of abrasions and cuts to ensure a watertight seal.

Model	Housing, Washer, Nut or spacer	Hull Nut	Cap Nut (Retractable Only)	Blanking Plug
B17	33-100 (low profile)			
B21	33-224-01 (counter bore)	02-030	04-011 (plastic)	33-414
B119	33-091-01 (flush)		02-131-01 (bronze)	
B22	—			
B117	04-646-01 (spacer)	02-030	—	—
B124				
P17	33-417 (low profile)			
P217	33-217 (flush)	04-004	04-011	33-414
P314	33-092-01 (counter bore)			
P19	—			
P219	—	04-004		
P269				
P319	04-646-01 (spacer)			
SS555		20-299-01		
SS575	04-646-01 (spacer)	04-186-1 (isolation bushing)		
		20-299-01		
SS577	33-495-01	04-186-1 (isolation bushing)	04-011 (plastic)	33-414

Transducer Replacement

The information needed to order a replacement Airmar transducer is printed on the cable tag. *Do not* remove this tag. When ordering, specify the part number, date, and frequency in kHz. For convenient reference, record this information on the top of page one.

Where to Purchase

Obtain parts from your instrument manufacturer or marine dealer.

Gemeco (USA) Tel: 843.394.3565
Fax: 843.394.3736
email: sales@gemeco.com

Airmar Europe Tel: +45.45.81.04.18
Fax: +45.45.81.04.93
email: sales@airmareurope.com

AIRMAR®
TECHNOLOGY CORPORATION

35 Meadowbrook Drive, Milford, New Hampshire 03055-4613, USA

• www.airmar.com